

PRODUCT CATALOG

V18.9

Sur-Pro's Identity is Innovating for the Professional Contractor

Magnum Tool Corp., Inc. was founded in 1989 primarily as a hand-tool wholesaler targeting the Houston Market. As the company grew, it saw a need for high quality, professional tools designed for drywall contractors. To target this market, the Magnum Tool Corp., Inc. created the Sur-Pro brand. Today Sur-Pro products can be found everywhere in the US and many international locations such as Canada and the UK.

The Sur-Pro Line

In 1995 Magnum's sister company, The Forest Group, Inc., introduced the Sur-Stilt drywall stilts. The Sur-Stilt takes elements from the traditional drywall tools and adds features that transforms the user's experience. Stronger, more reliable construction, new pioneering use of materials, and innovative engineering led to the introduction of the patented S2 Double Sided Sur-Stilt. In 2016, the engineers at The Forest Group introduced even more features to improve comfort, stability, and safety in the signature QuadLock stilt line.

Sur-Pro has also received incredible feedback for its Dump Carts, Drywall Carts and other tools that were re-engineered to excel on the roughest construction site. Sur-Pro engineers redesigned our dump cart tubs to tilt easily, navigate smoothly through elevators and doors, and stack efficiently for better storage and shipping. The team added heavy duty wheels and casters, lids, and continue to innovate and customize to create stronger products.



The Sur-Pro Family's Commitment to Our Products and Customers

The Magnum Tool Corp., Inc. and The Forest Group, Inc. stand behind their products and services and offer the industry's best warranties and customer support. Our devoted team of engineers, customer service representatives, and product experts work in tandem to ensure the highest level of customer satisfaction.

Have a question, product recommendation, or reviews? Do not hesitate to contact us and please ask to join our mailing list!

TABLE OF CONTENTS

MATERIAL HANDLING 03

| | |
|------------------------------------|-------|
| Dump Carts and Accessories | 4-6 |
| Drywall Carts and Accessories | 7-8 |
| Dump Cart and Drywall Cart Pallets | 9 |
| Wheelbarrows | 10 |
| Pallet Jack and Flat Cart | 11 |
| Casters and Tires | 12-13 |

ACOUSTICAL TOOLS 14

| | |
|------------------------------|-------|
| Lag Poles and Attachments | 15-16 |
| Poles and Wire Tying Machine | 17 |
| Celling Tools | 17-18 |

WORK PLATFORMS 19

| | |
|-------------------------------|----|
| Step-Up Benches | 20 |
| Drywall Bench and Accessories | 21 |

DRYWALL TOOLS 22

| | |
|-------------------------|-------|
| Drywall Hanging Tools | 23-24 |
| Drywall Finishing Tools | 25 |

MATERIALS 26

| | |
|---------------------------------|----|
| Drywall Screws | 27 |
| Duplex Nails and Eye Lag Screws | 28 |
| Straight Wire | 29 |
| Pre-Tied Wire | 30 |
| Pins and Clips | 31 |
| Tie Wire and Pony Wall Supports | 32 |

HAND TOOLS 33

| | |
|------------------------------------|-------|
| Tin Snips, Utility Knives & Blades | 34 |
| Tie-Downs | 35 |
| Tie Wire Tools | 36 |
| Construction Tools | 36 |
| Magnetic Nutsetters | 37-38 |
| Bits and Bit Tip Holders | 38 |
| Tarps | 39 |

WORK GEAR 39

| | |
|-----------------------------|-------|
| Leather Pouches and Holders | 39-40 |
| Leather Belts and Hard Hats | 40 |
| Safety Vests | 41 |

DRYWALL STILTS 42

| | |
|---------------------------------------|-------|
| QuadLock Stilts | 43-44 |
| Sur-Stilts and Stilt Replacement Kits | 45-46 |
| Stilt Replacement Parts | 47 |

MERCHANDISE DISPLAYS 48

| | |
|----------------------|----|
| Merchandise Displays | 49 |
|----------------------|----|





Sur-Pro[®]
MATERIAL HANDLING

**CONQUER
ANY
WORKSITE**



DUMP CARTS

DUC12T



1/2 Cubic Yard Dump Cart (Injection Molded)

- Dumping can be performed by a single user
- Smooth surface is easy to clean and resists corrosion
- Fits through standard doorways and elevators
- Save freight and space by stacking more on a pallet
- Construction grade wheels and casters

| | |
|---------------|--------|
| LOAD CAPACITY | 750 LB |
| ITEM WEIGHT | 64 LB |
| PALLET COUNT | 14 |

MATERIAL HANDLING



CAS10

10" Wheel

ITEM WEIGHT BOX COUNT PURCHASE UNIT

7 LB 2 1 WHEEL



CAS4PS

4" X 2" Swivel Caster w/Plate

4 LB 10 1 CASTER



DUA12-550

21-5/8" Replacement Axle

3 LB 1 1 AXLE



DUL12T

Lid for 1/2 Yard Dump Cart (DUC12T)

12 LB 1 LID

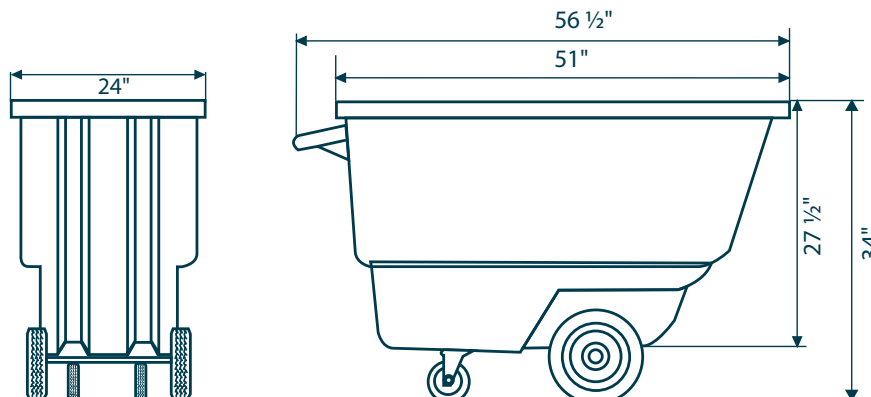

DUMP CARTS

DUC 100-12

1 Cubic Yard Covered Capacity
Dump Cart (Injection Molded)

| | |
|---------------|--------|
| LOAD CAPACITY | 800 LB |
| ITEM WEIGHT | 89 LB |
| PALLET COUNT | 12 |

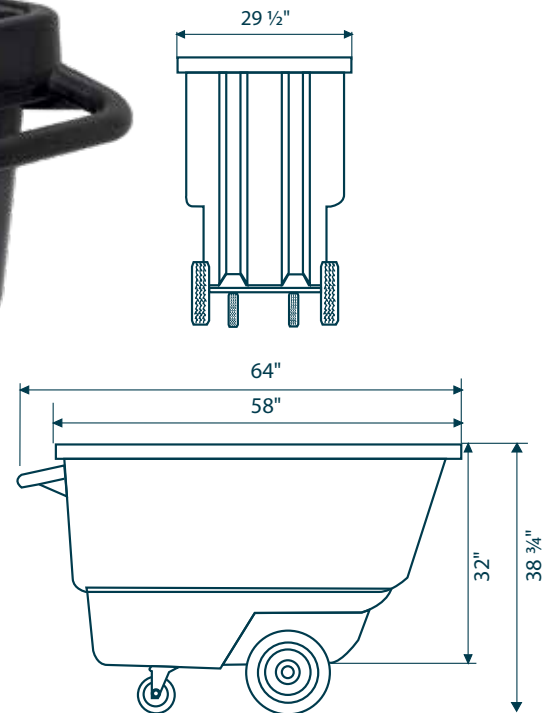

DUMP CART ACCESSORIES

DUL 100

Lid for 1 Cubic Yard Covered
Capacity Dump Cart

| | |
|---------------|-------|
| ITEM WEIGHT | 17 LB |
| PURCHASE UNIT | 1 LID |



DUMP CART WITH FRAME



DUC100-R

1 Cubic Yard Covered Capacity Dump Cart with Reinforcing Frame and Plate Casters

LOAD CAPACITY 1000 LB
ITEM WEIGHT 94 LB
PALLET COUNT 12

DUF100R

Reinforcing Frame for 1 Cubic Yard Covered Capacity Dump Cart

ITEM WEIGHT 5 LB



DUC100-H

1 Cubic Yard Covered Capacity Dump Cart with Heavy Duty Full Frame and Plate Casters

LOAD CAPACITY 1200 LB
ITEM WEIGHT 112 LB
PALLET COUNT 10

DUF100H

Heavy Duty Full Frame for 1 Cubic Yard Covered Capacity Dump Cart

ITEM WEIGHT 23 LB

DUMP CART ACCESSORIES

CAS12



12" Wheel for 1 Yard Dump Cart

ITEM WEIGHT 11 LB
BOX COUNT 2
PURCHASE UNIT 1 WHEEL

CAS4W



4" Caster (with Stem)

ITEM WEIGHT 2 LB
BOX COUNT 10
PURCHASE UNIT 1 CASTER

CAS5PS



5" x 2" Swivel Caster (with Plate)

ITEM WEIGHT 4 LB
BOX COUNT 10
PURCHASE UNIT 1 CASTER

DUA100-12



24 -4/5" Replacement Axle for DUC100

ITEM WEIGHT 4 LB
BOX COUNT 1
PURCHASE UNIT 1 AXLE

DRYWALL CARTS

DOR04

Cart with Non-Marking Casters

Residential Drywall Cart

LOAD CAPACITY 3200 LB
ITEM WEIGHT 69 LB
PALLET COUNT 12

- 2 swivel casters and 2 swivel casters with locks
- Non-marking or PU casters
- 38" x 10" nylon skid plate for easy loading
- High quality powder coated finish

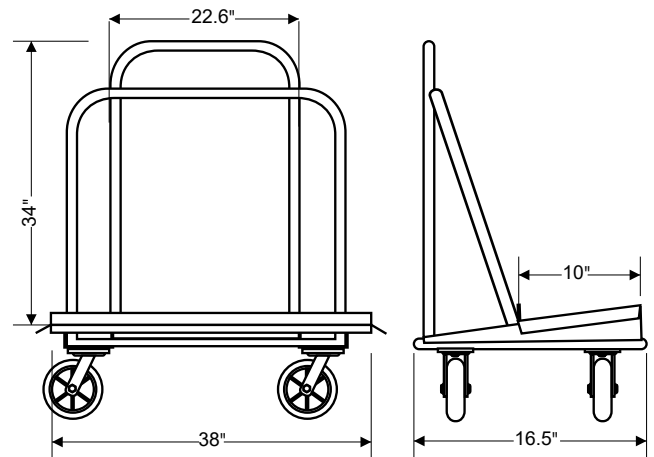

DOA3200

Cart with Non-Marking Casters

Commercial Drywall Cart

LOAD CAPACITY 3200 LB
ITEM WEIGHT 85 LB
PALLET COUNT 12

- 2 swivel casters and 2 swivel casters with locks
- Non-marking or PU casters
- 40" x 12" steel plate
- High quality powder coated finish

DOA3200PU

Cart with Polyurethane Casters

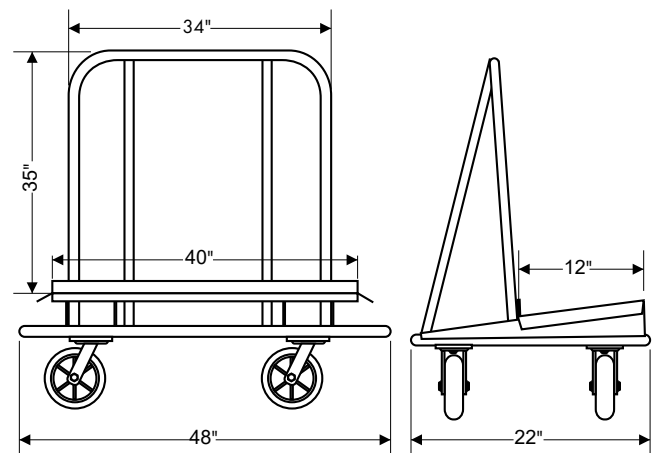

DRYWALL CART ACCESSORIES



DOR02-P

Replacement Plate for Residential Drywall Cart

ITEM DIMENSIONS 38"X10"X0.4" ITEM WEIGHT 5 LB BOX COUNT 10 PURCHASE UNIT 1 PLATE



DO-A

Drywall Cart Replacement Caster Kit with Nuts and Bolts

(Non-Marking Casters: 2 Swivel, 2 Swivel with Lock)

BOX WEIGHT 25 LB
PURCHASE UNIT 1 BOX



DO-APU

Drywall Cart Replacement Caster Kit with Nuts and Bolts

(Polyurethane Casters: 2 Swivel, 2 Swivel with Lock)

BOX WEIGHT 36 LB
PURCHASE UNIT 1 BOX

DUMP CART & DRYWALL CART PALLETS

Sur-Pro dump carts and drywall carts are designed for efficient shipping and storage. Please contact us at 1.888.443.8889 for more details and full pallet pricing.

Mix and match different dump cart configurations and sizes with lids to qualify for full pallet pricing and prepaid shipping. Pallet examples:

- 14 x DUC12T + 3 lids
- 12 x DUC100-12 + 3 lids
- 12 x DUC100-R + 3 lids
- 10 mixed dump carts + 6 lids
- 12 mixed dump carts + 3 lids
- * Excludes DUC100-H

Mix and match commercial drywall carts (DOA3200) and residential drywall carts (DOR04) on one pallet (full pallet is 10 carts) to qualify for full pallet pricing and prepaid shipping.

Mix of up to 12 carts with even numbers for either model.

Examples: 6 commercial & 6 residential carts

8 commercial & 4 residential carts



WHEELBARROWS

BAWH6-SH

6-Cu Ft Steel Wheelbarrow with Steel Handles



- 6 cubic feet capacity
- Heavy duty steel tray
- Strong steel handles
- 16" flat-free tires

| | |
|---------------|--------|
| LOAD CAPACITY | 440 LB |
| ITEM WEIGHT | 49 LB |

BAWH6-WH

6-Cu Ft Steel Wheelbarrow with Wood Handles



- 6 cubic feet capacity
- Heavy duty steel tray
- Strong wood handles
- 16" air tire

| | |
|---------------|--------|
| LOAD CAPACITY | 440 LB |
| ITEM WEIGHT | 46 LB |

PALLET JACK



JAP3

3 Ton Pallet Jack

- Load capacity: 6600 LB
- 3-position lever control: raise, neutral, and lower
- Ergonomic large handle for easier handling
- 210° steering arc allows maximum maneuverability
- Leak-proof pump

| | |
|---------------------|------------------|
| FORK SIZE | 48" X 27" |
| FORK WIDTH | 6" |
| ITEM WEIGHT | 157 LB |
| PALLET COUNT | 5 |

FLAT CART



CAFM2247

Steel Plate Flat Cart with Non-Marking Casters

- Load capacity: 3200 LB
- 2 fixed casters
- 1 swivel and 1 swivel caster with lock
- Non-marking casters
- 43" x 22" steel plate
- High quality powder coated finish

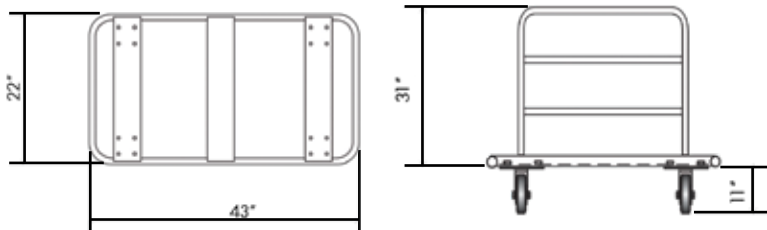

| | |
|-----------------------|-------------------|
| ITEM WEIGHT | 68 LB |
| BOX DIMENSIONS | 47"X24"X4" |
| PALLET COUNT | 20 |

CASTERS

STEM CASTERS

CAS3W



| | |
|-----------------|----------|
| CASTER DIAMETER | 3" |
| CASTER WIDTH | 2" |
| ITEM WEIGHT | 1.43 LB |
| BOX COUNT | 20 |
| PURCHASE UNIT | 1 CASTER |

CAS4W



| | |
|-----------------|----------|
| CASTER DIAMETER | 4" |
| CASTER WIDTH | 2" |
| ITEM WEIGHT | 1.9 LB |
| BOX COUNT | 20 |
| PURCHASE UNIT | 1 CASTER |

CAS5RL



| | |
|-----------------|----------|
| CASTER DIAMETER | 5" |
| CASTER WIDTH | 2" |
| ITEM WEIGHT | 3.5 LB |
| BOX COUNT | 10 |
| PURCHASE UNIT | 1 CASTER |

CAS5SL



| | |
|-----------------|----------|
| CASTER DIAMETER | 5" |
| CASTER WIDTH | 2" |
| ITEM WEIGHT | 4.4 LB |
| BOX COUNT | 10 |
| PURCHASE UNIT | 1 CASTER |

NON-MARKING CASTERS



| | TYPE | CASTER DIAMETER | CASTER WIDTH | WEIGHT | BOX COUNT | PURCHASE UNIT |
|-----------|------------------|-----------------|--------------|--------|-----------|---------------|
| CAS800F-Y | FIXED | 8" | 2" | 4 LB | 4 | 1 CASTER |
| CAS800S-Y | SWIVEL | 8" | 2" | 6 LB | 4 | 1 CASTER |
| CAS800B-Y | SWIVEL W/LOCK | 8" | 2" | 6.5 LB | 4 | 1 CASTER |

CASTERS WITH PLATE



| | TYPE | CASTER DIAMETER | CASTER WIDTH | WEIGHT | BOX COUNT | PURCHASE UNIT |
|--------|--------|-----------------|--------------|---------|-----------|---------------|
| CAS4PF | FIXED | 4" | 2" | 3.37 LB | 20 | 1 CASTER |
| CAS5PF | FIXED | 5" | 2" | 3.8 LB | 10 | 1 CASTER |
| CAS6PF | FIXED | 6" | 2" | 4.2 LB | 10 | 1 CASTER |
| CAS4PS | SWIVEL | 4" | 2" | 4.12 LB | 20 | 1 CASTER |
| CAS5PS | SWIVEL | 5" | 2" | 4.6 LB | 10 | 1 CASTER |
| CAS6PS | SWIVEL | 6" | 2" | 4.9 LB | 10 | 1 CASTER |

CASTERS & TIRES

RUBBER CASTERS



| | TYPE | CASTER DIAMETER | CASTER WIDTH | WEIGHT | BOX COUNT | PURCHASE UNIT |
|--------|---------------|-----------------|--------------|--------|-----------|---------------|
| CAS8F | FIXED | 8" | 2" | 8 LB | 4 | 1 CASTER |
| CAS8S | SWIVEL | 8" | 2" | 8 LB | 4 | 1 CASTER |
| CAS8BR | SWIVEL W/LOCK | 8" | 2" | 9 LB | 4 | 1 CASTER |

POLYURETHANE CASTERS



| | TYPE | CASTER DIAMETER | CASTER WIDTH | WEIGHT | BOX COUNT | PURCHASE UNIT |
|---------|---------------|-----------------|--------------|--------|-----------|---------------|
| CAS8FPU | FIXED | 8" | 2" | 8 LB | 4 | 1 CASTER |
| CAS8SPU | SWIVEL | 8" | 2" | 9 LB | 4 | 1 CASTER |
| CAS8BPU | SWIVEL W/LOCK | 8" | 2" | 9 LB | 4 | 1 CASTER |

TIRES



| | TYPE | TIRE DIAMETER | TIRE WIDTH | WEIGHT | BOX COUNT | PURCHASE UNIT |
|-------|----------|---------------|------------|--------|-----------|---------------|
| TIA10 | Air Tire | 10" | 3" | 3.5 LB | 10 | 1 TIRE |



| | | | | | | |
|----------|------------|-----|------|--------|----|--------|
| TIS10-58 | Solid Tire | 10" | 2.5" | 6.2 LB | 10 | 1 TIRE |
|----------|------------|-----|------|--------|----|--------|



| | | | | | | |
|-------|----------|-----|----|--------|---|--------|
| TIA16 | Air Tire | 16" | 4" | 5.3 LB | 4 | 1 TIRE |
|-------|----------|-----|----|--------|---|--------|



| | | | | | | |
|-------|----------------|-----|----|--------|---|--------|
| TIS16 | Flat-Free Tire | 16" | 4" | 6.4 LB | 4 | 1 TIRE |
|-------|----------------|-----|----|--------|---|--------|



| | | | | | | |
|-------|---------------|----|------|--------|----|--------|
| TINF8 | Non-Flat Tire | 8" | 2.5" | 2.1 LB | 10 | 1 TIRE |
|-------|---------------|----|------|--------|----|--------|



| | | | | | | |
|----------|---------------|-----|------|--------|----|--------|
| TINF1035 | Non-Flat Tire | 10" | 3.5" | 3.7 LB | 10 | 1 TIRE |
|----------|---------------|-----|------|--------|----|--------|



ACOUSTICAL TOOLS



LAG POLES



DURABLE LIGHTWEIGHT ALUMINUM CONSTRUCTION

- Telescopic pole for height adjustability
- Quick set-up
- Fast wire attachment
- Works with 12 or 8 gauge wire
- Uses standard 1/2" variable speed drill
- Commercial grade

TELESCOPIC LAG POLES



| | MIN & MAX EXTENSION | NUMBER OF SECTIONS | ITEM WEIGHT | TUBE DIMENSIONS | PURCHASE UNIT |
|---------------|---------------------|--------------------|-------------|-----------------|---------------|
| TOP6 | 3' - 6' | 2 | 2.3 LB | 42"x3"x3" | 1 POLE |
| TOP123 | 4' - 12' | 3 | 5.5 LB | 55"x3"x3" | 1 POLE |
| TOP12 | 6' - 12' | 2 | 6.8 LB | 85"x3"x3" | 1 POLE |
| TOP18 | 6' - 18' | 3 | 8.8 LB | 85"x3"x3" | 1 POLE |
| TOP24 | 8' - 24' | 3 | 10.6 LB | 103"x3"x3" | 1 POLE |











DRLO1



Lag Screw Driver (10 PC/PACK)

| | |
|---------------|---------|
| PACK WEIGHT | 1.17 LB |
| BOX COUNT | 36 PACK |
| PURCHASE UNIT | 1 PACK |

LAG POLE ATTACHMENTS

| | | ITEM WEIGHT | PURCHASE UNIT |
|--|---|-------------|---------------|
|  | TOPP1 Lag Pole Replacement Head | 0.56 LB | 1 PC |
|  | TOPP212 Lag Pole Drill Attachment for TOP6 & TOP12 | 0.54 LB | 1 PC |
|  | TOPP218 Lag Pole Drill Attachment for TOP123, TOP18 & TOP24 | 0.67 LB | 1 PC |
|  | TOPP3 Lag Pole Adjustment Clip | 0.07 LB | 1 PC |
|  | TOPP4 Installation Tool for Pre-Tied Lag Screws Adapter | 0.83 LB | 1 PC |
|  | TOPP5 Purlin Clip Tool Adapter | 0.33 LB | 1 PC |
|  | TOPP5A Installation Tool for Bar Joist Clip | 0.36 LB | 1 PC |
|  | TOPP5A-A Accessories for TOPP5A | 0.04 LB | 1 PC |
|  | TOPP6 Powder Actuated Tool Adapter | 0.23 LB | 1 PC |
|  | TOPP7 Lag Pole Screw with Washer | 0.01 LB | 1 PC |
|  | TOPP8 Hex Head Attachment for Lag Poles | 0.27 LB | 1 PC |

EXTENSION POLES



| | MIN & MAX EXTENSION | NUMBER OF SECTIONS | ITEM WEIGHT | TUBE DIMENSIONS | BOX COUNT | PURCHASE UNIT |
|----------------|---------------------|--------------------|-------------|-----------------|-----------|---------------|
| TOP8V | 4' - 8' | 2 | 5 LB | 55"x3"x3" | 6 POLES | 1 POLE |
| TOP123V | 4' - 12' | 3 | 6 LB | 55"x3"x3" | 6 POLES | 1 POLE |
| TOP12V | 6' - 12' | 2 | 6 LB | 80"x3"x3" | 6 POLES | 1 POLE |
| TOP183V | 6' - 18' | 3 | 8 LB | 80"x3"x3" | 6 POLES | 1 POLE |

WIRE TYING MACHINE



WIT110

Wire Tying Machine

- 110V motor
- Foot pedal or button operation
- Ties 12 gauge wire
- Can assemble double ties

BOX DIMENSIONS 19"x19"x15"
WEIGHT 85 LB

CEILING TOOLS



PLP01

1/8" Grid Punch Pliers

ITEM WEIGHT 1.05 LB
BOX COUNT 48
PURCHASE UNIT 1 PC



REP01

Repair Kit for 1/8" Grid Punch Pliers

ITEM WEIGHT 0.06 LB
BOX COUNT 1000
PURCHASE UNIT 1 KIT

CEILING TOOLS

4" ACOUSTICAL SPRING CLAMP



CLS4H

ITEM WEIGHT BOX COUNT CASE COUNT PURCHASE UNIT

0.15 LB 6 PC 40 BOX 1 PC

CLS4H-2

PACK WEIGHT PACK COUNT CASE COUNT PURCHASE UNIT

0.32 LB 2 PC N/A 1 PACK

6" ACOUSTICAL SPRING CLAMP



CLS6H

ITEM WEIGHT BOX COUNT CASE COUNT PURCHASE UNIT

0.28 LB 6 PC 20 BOX 1 PC

CLS6H-2

PACK WEIGHT PACK COUNT CASE COUNT PURCHASE UNIT

0.60 LB 2 PC N/A 1 PACK

4" RUBBER TIPPED LEVER ACTION GRID CLAMP



CLR01

ITEM WEIGHT BAG COUNT CASE COUNT PURCHASE UNIT

0.07 LB 25 PC 20 BAG 1 PC

CLR01-12

PACK WEIGHT PACK COUNT CASE COUNT PURCHASE UNIT

0.87 LB 12 PC N/A 1 PACK

450' CEILING GRID ALIGNMENT LINE



LIJ450

BOX WEIGHT BOX COUNT CASE COUNT PURCHASE UNIT

1.89 LB 50 ROLL 10 BOX 1 PC

LIJ450-3

PACK WEIGHT PACK COUNT CASE COUNT PURCHASE UNIT

0.12 LB 3 ROLL N/A 1 PACK

1400' CEILING GRID ALIGNMENT LINE



LIJ1400

BOX WEIGHT BOX COUNT CASE COUNT PURCHASE UNIT

1.63 LB 15 ROLL 10 BOX 1 PC

LIJ1400-3

PACK WEIGHT PACK COUNT CASE COUNT PURCHASE UNIT

0.32 LB 3 ROLL N/A 1 PACK



WORK PLATFORMS



STEP-UP BENCHES

DURABLE LIGHTWEIGHT ALUMINUM CONSTRUCTION

- Bench top load capacity: 300 LB
- Reinforced fully enclosed crossbeam structure adds durability with a more stable surface
- Hex cap (partially threaded) bolts reduce joint wear and increase longevity of the product
- Double-rivets create a safer and further reinforced step-up bench
- Meets all OSHA requirements



STS2

2' Step-Up Bench with 10" Top

| | |
|----------------|-------------|
| ITEM WEIGHT | 14.5 LB |
| BOX COUNT | 2 BENCH |
| BOX DIMENSIONS | 32"x27"x16" |
| PURCHASE UNIT | 1 BENCH |



STS212

2½' Step-Up Bench with 10" Top

| | |
|----------------|-------------|
| ITEM WEIGHT | 15.5 LB |
| BOX COUNT | 2 BENCH |
| BOX DIMENSIONS | 34"x33"x16" |
| PURCHASE UNIT | 1 BENCH |



STS3

3' Step-Up Bench with 10" Top

| | |
|----------------|-------------|
| ITEM WEIGHT | 20.5 LB |
| BOX COUNT | 2 BENCH |
| BOX DIMENSIONS | 39"x36"x16" |
| PURCHASE UNIT | 1 BENCH |



STS4

4' Step-Up Bench with 10" Top

| | |
|----------------|-------------|
| ITEM WEIGHT | 26 LB |
| BOX COUNT | 2 BENCH |
| BOX DIMENSIONS | 51"x36"x16" |
| PURCHASE UNIT | 1 BENCH |

DRYWALL BENCH

BEZ4000



ADJUSTABLE HEIGHT DRYWALL BENCH

- High quality aluminum, heat treated for extra strength
- Adjustable height
- Patented EZ locking system adjusts from 18" to 30" in 2" increments
- Stable triangle step-up bar for extension legs featuring easy tear drop attachment system
- Foldable for easy transport
- Step-up capacity up to 250 LB
- Bench-top capacity up to 500 LB
- Meets all OSHA requirements

| | |
|-----------------------|--------------|
| BOX WEIGHT | 36 LB |
| BOX DIMENSIONS | 19.5"x8"x50" |
| BOX COUNT | 1 PC |
| PALLET COUNT | 20 PC |

BENCH ACCESSORIES



EZ003

Standard Leg

ITEM WEIGHT

1.32 LB

PURCHASE UNIT

1 PC



EZ006A

Aluminum EZ Lock Repair Kit

0.2 LB

1 KIT

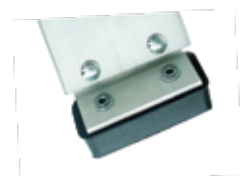

EZ010

Leg Pad

0.13 LB

1 PC

SurPro[®] DRYWALL TOOLS

DRYWALL TOOLS



22

DRYWALL HANGING TOOLS



BEC114

1 1/4" Corner Bead Crimper

ITEM WEIGHT 2.2 LB BOX COUNT 12 PC PURCHASE UNIT 1 PC

BEC118



1-1/8" Corner Bead Crimper

ITEM WEIGHT 2.20 LB
BOX COUNT 12 PC
PURCHASE UNIT 1 PC

CUD01



Drywall Circle Cutter with Graduated Shaft

ITEM WEIGHT 0.56 LB
BOX COUNT 6 PC
CASE COUNT 6 BOX
PURCHASE UNIT 1 PC

MARU24



24 oz. Rubber Mallet with Wood Handle

ITEM WEIGHT 2.11 LB
BOX COUNT 6 PC
CASE COUNT 4 BOX
PURCHASE UNIT 1 PC

MARU32



32 oz. Rubber Mallet with Wood Handle

ITEM WEIGHT 3 LB
BOX COUNT 6 PC
CASE COUNT 4 BOX
PURCHASE UNIT 1 PC

PLF512



5-1/2" Drywall Rasp

ITEM WEIGHT 0.43 LB
BOX COUNT 6 PC
CASE COUNT 12 BOX
PURCHASE UNIT 1 PC

BLF02



5-1/2" Rasp Replacement Blades (2-Pack)

ITEM WEIGHT 0.01 LB
PACK COUNT 2 PC
BOX COUNT 100 PACK
PURCHASE UNIT 1 PACK

DRYWALL HANGING TOOLS



HAD14

14" Drywall Hammer - Convex, Serrated Face, Forged Steel Head, Hickory Handle

ITEM WEIGHT 1.39 LB BOX COUNT 48 PC PURCHASE UNIT 1 PC

HAD16



16" Drywall Hammer - Convex, Serrated Face, Forged Steel Head, Hickory Handle

ITEM WEIGHT 1.5 LB
BOX COUNT 48 PC
PURCHASE UNIT 1 PC

GUC9



9" Ratchet Caulk Gun

ITEM WEIGHT 0.85 LB
BOX COUNT 24 PC
PURCHASE UNIT 1 PC

GUC13



13" Ratchet Caulk Gun

ITEM WEIGHT 2.04 LB
BOX COUNT 12 PC
PURCHASE UNIT 1 PC

LIR01



Drywall Roll Lifter

ITEM WEIGHT 2.58 LB
BOX COUNT 24 PC
PURCHASE UNIT 1 PC

LIF01



Drywall Foot Lifter

ITEM WEIGHT 1.49 LB
BOX COUNT 16 PC
PURCHASE UNIT 1 PC

SAPM9F



9" x 3 1/4" Metal Pole Sander, Female Thread

ITEM WEIGHT 0.83 LB
BOX COUNT 60 PC
PURCHASE UNIT 1 PC

DRYWALL FINISHING TOOLS

TAM2300W



2" x 300' Fiberglass Mesh Tape - White

ITEM WEIGHT 0.8 LB
BOX COUNT 30
PURCHASE UNIT 1 PC

HOA14100PU-B



100' Roofing Framing P.U. Air Hose 1/4 NPT Fitting

ITEM WEIGHT 2.45 LB
BOX COUNT 14
PURCHASE UNIT 1 PC

BANJOD



Drywall Taper

ITEM WEIGHT 4.4 LB
BOX COUNT 4
PURCHASE UNIT 1 PC



DRYWALL TAPER REPLACEMENT PARTS AVAILABLE!

DIE CAST MUD MIXER



MIM24

ITEM LENGTH ITEM WEIGHT BOX COUNT CASE COUNT PURCHASE UNIT

24" 1.67 LB 6 PC 2 BOX 1 PC

MIM30

30" 1.91 LB 6 PC 2 BOX 1 PC

TWO-WHEEL 5" MUD MIXER



MIM5

ITEM LENGTH ITEM WEIGHT BOX COUNT CASE COUNT PURCHASE UNIT

24" 1.68 LB 6 PC 4 BOX 1 PC

STAINLESS STEEL MUD PANS W/ROUND BOTTOM AND NON-SLIP GRIP



PAM12SR

ITEM LENGTH ITEM WEIGHT BOX COUNT CASE COUNT PURCHASE UNIT

12" 1.22 LB 10 PC 3 BOX 1 PC

PAM14SR

14" 1.33 LB 10 PC 3 BOX 1 PC

GRIPST

ITEM WEIGHT PURCHASE UNIT
Non-Slip Grip 9"x7" Sheet for Mud Pans 0.06 LB 1 PC

STAINLESS STEEL MUD PANS W/ROUND BOTTOM



PAM12S

ITEM LENGTH ITEM WEIGHT BOX COUNT CASE COUNT PURCHASE UNIT

12" 1.16 LB 10 PC 3 BOX 1 PC

PAM14S

14" 1.27 LB 10 PC 3 BOX 1 PC

DIE-CUT SANDING DISCS

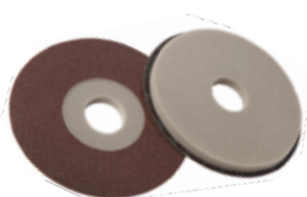

BOX WEIGHT BOX COUNT CASE COUNT PURCHASE UNIT

1.7 LB 5 PC 36 BOX 1 BOX

DIS080 DIS100 DIS120 DIS150 DIS180

AVAILABLE GRIT SIZES: 80 - 180 GRIT

SurPro[®]

MATERIALS





PREMIUM QUALITY DRYWALL SCREWS

- Steel construction
- For attaching gypsum board to steel studs (SDS114-F & SDS114) or wood studs (SDS114-C)
- Sharp point and bugle head for a clean finish (SDS114-C & SDS114-F)
- Phosphate coated (SDS114-C & SDS114-F) and Zinc-Plated (SDD114)

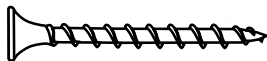

SDS114-C

1-1/4" Coarse Thread
Bugle Head #2 Phillips

| | |
|---------------|---------|
| ITEM WEIGHT | 28 LB |
| BOX COUNT | 8000 PC |
| PALLET COUNT | 48 BOX |
| PURCHASE UNIT | 1 BOX |



SDS114-F

1-1/4" Fine Thread
Bugle Head #2 Phillips

| | |
|---------------|---------|
| ITEM WEIGHT | 29 LB |
| BOX COUNT | 8000 PC |
| PALLET COUNT | 48 BOX |
| PURCHASE UNIT | 1 BOX |



SDD114

1-1/4" Self-Drilling
Bugle Head #2 Phillips

| | |
|---------------|---------|
| ITEM WEIGHT | 32 LB |
| BOX COUNT | 8000 PC |
| PALLET COUNT | 48 BOX |
| PURCHASE UNIT | 1 BOX |

DUPLEX NAILS AND EYE LAG SCREWS

16D BRIGHT DUPLEX NAILS

| | THREAD LENGTH | TOTAL LENGTH | BOX WEIGHT | PALLET COUNT |
|---|---------------|--------------|------------|--------------|
|  NABD-16 | 3" | 3½" | 50 LB | 48 BOX |

LONG SELF-TAPPING SHARP POINT EYE LAG SCREWS

| | THREAD LENGTH | TOTAL LENGTH | BOX WEIGHT | BOX COUNT | PALLET COUNT |
|--|---------------|--------------|------------|-----------|--------------|
|  SCSP112-100 | 1 ½" | 2 ¾" | 2.6 LB | 100 PC | N/A |
| SCSP112-1000 | 1 ½" | 2 ¾" | 27 LB | 1000 PC | 48 BOX |

| | | | | | |
|--|----|------|--------|---------|--------|
|  SCSP2-100 | 2" | 3 ¼" | 2.8 LB | 100 PC | N/A |
| SCSP2-1000 | 2" | 3 ¼" | 29 LB | 1000 PC | 48 BOX |

SELF-DRILLING EYE LAG SCREWS

| | THREAD LENGTH | TOTAL LENGTH | BOX WEIGHT | BOX COUNT | PALLET COUNT |
|---|---------------|--------------|------------|-----------|--------------|
|  SCSD345-100 | ¾" | 2" | 1.7 LB | 100 PC | N/A |
| SCSD345-1000 | ¾" | 2" | 18 LB | 1000 PC | 48 BOX |

| | | | | | |
|---|----|------|--------|---------|--------|
|  SCSD2-100 | 2" | 3 ¼" | 2.9 LB | 100 PC | N/A |
| SCSD2-1000 | 2" | 3 ¼" | 30 LB | 1000 PC | 48 BOX |

WOOD EYE LAG SCREWS

| | THREAD LENGTH | TOTAL LENGTH | BOX WEIGHT | BOX COUNT | PALLET COUNT |
|---|---------------|--------------|------------|-----------|--------------|
|  SCW3-100 | 1 ½" | 3" | 2.1 LB | 100 PC | N/A |
| SCW3-1000 | 1 ½" | 3" | 22 LB | 1000 PC | 100 BOX |

| | | | | | |
|---|------|----|--------|---------|--------|
|  SCW4-100 | 1 ½" | 4" | 2.9 LB | 100 PC | N/A |
| SCW4-1000 | 1 ½" | 4" | 30 LB | 1000 PC | 60 BOX |

| | | | | | |
|--|------|----|--------|---------|--------|
|  SCW5-100 | 1 ½" | 5" | 3.8 LB | 100 PC | N/A |
| SCW5-1000 | 1 ½" | 5" | 39 LB | 1000 PC | 60 BOX |

STRAIGHT WIRE



STRAIGHT WIRE

| STANDARD LENGHT | 8 GAUGE | 9 GAUGE | 12 GAUGE | BUNDLE SIZE |
|-----------------|-------------|-------------|--------------|-------------|
| 4 FT | WIR8-4-100 | WIR9-4-100 | WIR12-4-100 | 100 PC |
| 6 FT | WIR8-6-100 | WIR9-6-100 | WIR12-6-100 | 100 PC |
| 8 FT | WIR8-8-100 | WIR9-8-100 | WIR12-8-100 | 100 PC |
| 10 FT | WIR8-10-100 | WIR9-10-100 | WIR12-10-100 | 100 PC |
| 12 FT | WIR8-12-100 | WIR9-12-100 | WIR12-12-100 | 100 PC |
| 20 FT | WIR8-20-100 | WIR9-20-100 | WIR12-20-100 | 100 PC |
| 12 FT | | | WIR12-12-50 | 50 LB |
| 20 FT | | | WIR12-20-50 | 50 LB |

* CUSTOM LENGTHS AVAILABLE UPON REQUEST

STAINLESS STEEL STRAIGHT WIRE

| STANDARD LENGHT | 12 GAUGE | BUNDLE SIZE |
|-----------------|--------------|-------------|
| 4 FT | WIS12-4-100 | 100 PC |
| 8 FT | WIS12-8-100 | 100 PC |
| 10 FT | WIS12-10-100 | 100 PC |
| 12 FT | WIS12-12-100 | 100 PC |
| 20 FT | WIS12-20-100 | 100 PC |

* CUSTOM LENGTHS AVAILABLE UPON REQUEST

PRE-TIED WIRE

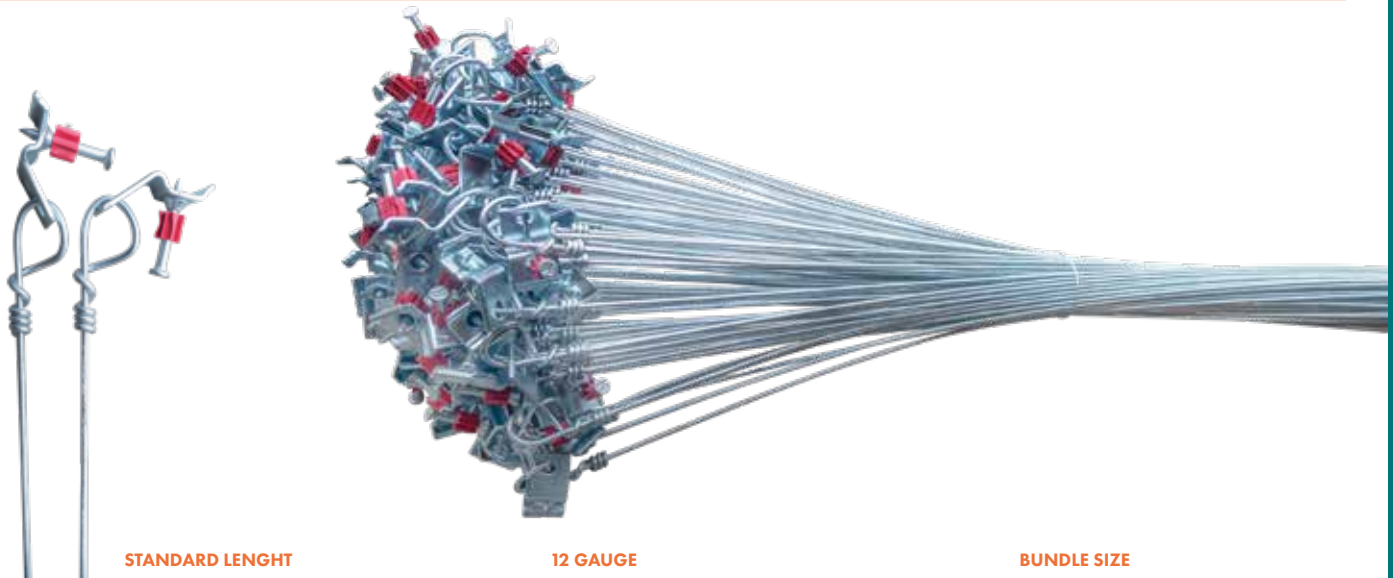

| STANDARD LENGTH | 12 GAUGE | BUNDLE SIZE |
|-----------------|--------------|-------------|
| 6 FT | WIW12-6-325 | 100 PC |
| 8 FT | WIW12-8-325 | 100 PC |
| 10 FT | WIW12-10-325 | 100 PC |
| 12 FT | WIW12-12-325 | 100 PC |
| 6 FT | WIW12-6-332 | 100 PC |
| 8 FT | WIW12-8-332 | 100 PC |
| 10 FT | WIW12-10-332 | 100 PC |
| 12 FT | WIW12-12-332 | 100 PC |

- All ties are certified 3 full-loop hospital ties (3 complete wraps within 1")
- Custom pre-tie service offered; Provide your own pins/clips to pre-tie
- All other in-stock pins and clips can be custom tied
- Double-tie services available

PLEASE CALL FOR A QUOTE



PINS AND CLIPS

1/4-20 X 4" -1/4 TOGGLE BOLT (ZINC-PLATED)



BOT144

| BOX WEIGHT | BOX COUNT | CASE COUNT | PURCHASE UNIT |
|------------|-----------|------------|---------------|
| 8.75 LB | 100 PC | 5 BOX | 1 BOX |

90 DEGREE ANGLE CLIP



CLA90

| BOX WEIGHT | BOX COUNT | CASE COUNT | PURCHASE UNIT |
|------------|-----------|------------|---------------|
| 27.5 LB | 1000 PC | 5 BOX | 1 BOX |

CEILING CLIP WITH 1" PIN



CLAS325

| BOX WEIGHT | BOX COUNT | PURCHASE UNIT |
|------------|-----------|---------------|
| 33 LB | 1000 PC | 1 BOX |

CLAS325-100

| BOX WEIGHT | BOX COUNT | PURCHASE UNIT |
|------------|-----------|---------------|
| 3.3 LB | 100 PC | 1 BOX |

CEILING CLIP WITH 1-1/4" PIN



CLAS332

| BOX WEIGHT | BOX COUNT | PURCHASE UNIT |
|------------|-----------|---------------|
| 35 LB | 1000 PC | 1 BOX |

CLAS332-100

| BOX WEIGHT | BOX COUNT | PURCHASE UNIT |
|------------|-----------|---------------|
| 3.5 LB | 100 PC | 1 BOX |

4-1/4" VERTICAL BAR JOIST CLIP



CLV4

| BOX WEIGHT | BOX COUNT | PURCHASE UNIT |
|------------|-----------|---------------|
| 47 LB | 1000 PC | 1 BOX |

CLV4-100

| BOX WEIGHT | BOX COUNT | PURCHASE UNIT |
|------------|-----------|---------------|
| 4.7 LB | 100 PC | 1 BOX |

2-7/8" Z-PURLIN CLIP



CLZ3

| BOX WEIGHT | BOX COUNT | PURCHASE UNIT |
|------------|-----------|---------------|
| 43 LB | 1000 PC | 1 BOX |

CLZ3-100

| BOX WEIGHT | BOX COUNT | PURCHASE UNIT |
|------------|-----------|---------------|
| 4.3 LB | 100 PC | 1 BOX |

ALL PINS AND CLIPS CAN BE SOLD AS PRE-TIE

TIE WIRE

DOUBLE LOOP WIRE TIES

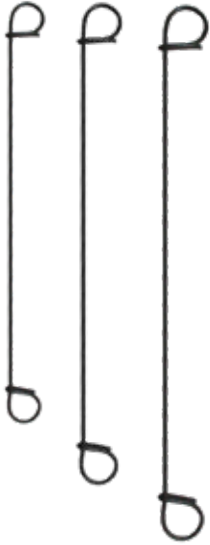

TIW174

TIW17412

TIW175

TIW17512

TIW176

TIW178

TIW1710

TIW1712

ITEM HEIGHT BAG COUNT PALLET COUNT PURCHASE UNIT

| ITEM HEIGHT | BAG COUNT | PALLET COUNT | PURCHASE UNIT |
|-------------|-----------|--------------|---------------|
| 4" | 5000 PC | 81 BAG | 1 BAG |
| 4½" | 5000 PC | 72 BAG | 1 BAG |
| 5" | 5000 PC | 63 BAG | 1 BAG |
| 5½" | 5000 PC | 63 BAG | 1 BAG |
| 6" | 5000 PC | 54 BAG | 1 BAG |
| 8" | 5000 PC | 45 BAG | 1 BAG |
| 10" | 5000 PC | 36 BAG | 1 BAG |
| 12" | 5000 PC | 27 BAG | 1 BAG |

WIBA-9-100LB



9-Gauge Black Annealed Wire

ITEM WEIGHT 100 LB
PALLET COUNT 20 COIL

WIBA-16-3.5LB



16-Gauge Tie Wire

ITEM WEIGHT 3.5 LB
BOX COUNT 20 COIL

PONY WALL SUPPORTS



SUPONY48

SUPONY60

SUPONY72

ITEM HEIGHT PALLET COUNT

| | |
|-----|-----|
| 48" | 100 |
| 60" | 100 |
| 72" | 100 |

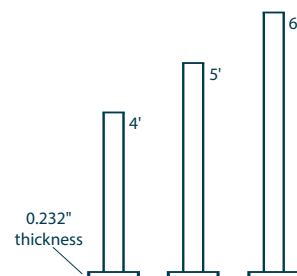
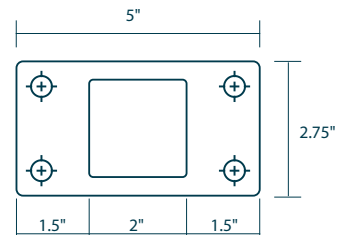

 **Sur-Pro[®]**
HAND TOOLS



TIN SNIPS



SNA100

Aviation Tin Snip (Center)

ITEM WEIGHT 1 LB
 BOX COUNT 36
 PURCHASE UNIT 1 PC



SNA101

Aviation Tin Snip (Right)

ITEM WEIGHT 1 LB
 WEIGHT 36
 PURCHASE UNIT 1 PC



SNA102

Aviation Tin Snip (Left)

ITEM WEIGHT 1 LB
 WEIGHT 36
 PURCHASE UNIT 1 PC

UTILITY KNIVES & BLADES



KNUHD

Heavy Duty Retractable Utility Knife

ITEM WEIGHT BOX COUNT CASE COUNT

0.33 LB 12 PC 6 BOX



KNUF

Fixed-Blade Utility Knife

0.29 LB 12 PC 6 BOX



KNUR

Retractable Utility Knife

0.29 LB 12 PC 6 BOX



BLHO10DS

Hook Blade w/Dispenser (10 PC)

0.11 LB 24 PACK 12 BOX



BLU10DS

Utility Blade w/Dispenser (10 PC)

0.12 LB 24 PACK 12 BOX



BLU100XD-9

Utility Blade w/Dispenser (100 PC)

0.92 LB 6 PACK 8 BOX



BLH100XD-9

Hook Blade w/Dispenser (100 PC)

0.72 LB 6 PACK 8 BOX

TIE-DOWNS

EPDM Rubber Tie-Downs with S-Hooks



TIR15H

ITEM LENGTH BAG COUNT CASE COUNT PURCHASE UNIT

15" 10 PC 10 BAG 1 BAG

TIR21H

21" 10 PC 10 BAG 1 BAG

TIR31H

31" 10 PC 10 BAG 1 BAG

TIR41H

41" 10 PC 10 BAG 1 BAG



TID115S

**1" x 15' 500 LB
J-Hook Nylon Ratchet
Tie-Down**

ITEM WEIGHT 1.27 LB
BOX COUNT 12
PURCHASE UNIT 1 PC



TID227F

**2" x 27' 10,000 LB
Flat Hook Ratchet
Tie-Down**

ITEM WEIGHT 5.5 LB
BOX COUNT 10
PURCHASE UNIT 1 PC



TID227J

**2" x 27' 10,000 LB
J-Hook Ratchet
Tie-Down**

ITEM WEIGHT 4.84 LB
BOX COUNT 10
PURCHASE UNIT 1 PC

TIE WIRE TOOLS



REW27A

Aluminum Tie Wire Reel

| | |
|----------------|----------|
| ITEM DIMENSION | 6"x6"x4" |
| ITEM WEIGHT | 1.7 LB |
| BOX COUNT | 10 PC |
| PURCHASE UNIT | 1 PC |



TIWTW

Tie Wire Twister

| | |
|---------------|---------|
| ITEM WEIGHT | 0.26 LB |
| BOX COUNT | 100 PC |
| PURCHASE UNIT | 1 PC |

CONSTRUCTION TOOLS

UTILITY WONDER BAR



BAW15

| ITEM SIZE | ITEM WEIGHT | BOX COUNT | PURCHASE UNIT |
|-----------|-------------|-----------|---------------|
| 15" | 1.09 LB | 24 | 1 PC |

ADJUSTABLE CONSTRUCTION WRENCHES



WRCA11

WRCA16

| ITEM SIZE | ITEM WEIGHT | BOX COUNT | PURCHASE UNIT |
|-----------|-------------|-----------|---------------|
| 11" | 1.09 LB | 24 | 1 PC |
| 16" | 2.24 LB | 24 | 1 PC |

HEAVY DUTY QUICK RELEASE CLAMPS



CLQ6H

CLQ12H

CLQ24H

CLQ36H

| ITEM SIZE | ITEM WEIGHT | BOX COUNT | PURCHASE UNIT |
|-----------|-------------|-----------|---------------|
| 6" | 1.1 LB | 30 | 1 PC |
| 12" | 1.5 LB | 30 | 1 PC |
| 24" | 1.7 LB | 20 | 1 PC |
| 36" | 2 LB | 20 | 1 PC |

MAGNETIC NUTSETTERS



| ITEM CODE | ITEM SIZE | PACK WEIGHT | PACK COUNT | BOX COUNT | PURCHASE UNIT |
|-----------|---------------|-------------|------------|-----------|---------------|
| SEN14S | 1/4" x 1-3/4" | 0.43 LB | 10 PC | 30 PACK | 1 PACK |



| ITEM CODE | ITEM SIZE | PACK WEIGHT | PACK COUNT | BOX COUNT | PURCHASE UNIT |
|-----------|----------------|-------------|------------|-----------|---------------|
| SEN516S | 5/16" x 1-3/4" | 0.48 LB | 10 PC | 40 PACK | 1 PACK |



| ITEM CODE | ITEM SIZE | PACK WEIGHT | PACK COUNT | BOX COUNT | PURCHASE UNIT |
|-----------|---------------|-------------|------------|-----------|---------------|
| SEN38S | 3/8" x 1-3/4" | 0.68 LB | 10 PC | 30 PACK | 1 PACK |



| ITEM CODE | ITEM SIZE | PACK WEIGHT | PACK COUNT | BOX COUNT | PURCHASE UNIT |
|-----------|----------------|-------------|------------|-----------|---------------|
| SEN14L | 1/4" x 2-9/16" | 0.63 LB | 10 PC | 40 PACK | 1 PACK |



| ITEM CODE | ITEM SIZE | PACK WEIGHT | PACK COUNT | BOX COUNT | PURCHASE UNIT |
|-----------|-----------------|-------------|------------|-----------|---------------|
| SEN516L | 5/16" x 2-9/16" | 0.73 LB | 10 PC | 30 PACK | 1 PACK |



| ITEM CODE | ITEM SIZE | PACK WEIGHT | PACK COUNT | BOX COUNT | PURCHASE UNIT |
|-----------|----------------|-------------|------------|-----------|---------------|
| SEN38L | 3/8" x 2-9/16" | 0.88 LB | 10 PC | 30 PACK | 1 PACK |



| ITEM CODE | ITEM SIZE | PACK WEIGHT | PACK COUNT | BOX COUNT | PURCHASE UNIT |
|-----------|-----------------|-------------|------------|-----------|---------------|
| SEN716L | 7/16" x 2-9/16" | 1.09 LB | 10 PC | 30 PACK | 1 PACK |

MAGNETIC NUTSETTERS



| ITEM CODE | ITEM SIZE | PACK WEIGHT | PACK COUNT | BOX COUNT | PURCHASE UNIT |
|-----------|-----------|-------------|------------|-----------|---------------|
| SEN146 | 1/4" x 6" | 1.43 LB | 10 PC | 40 PACK | 1 PACK |



| ITEM CODE | ITEM SIZE | PACK WEIGHT | PACK COUNT | BOX COUNT | PURCHASE UNIT |
|-----------|------------|-------------|------------|-----------|---------------|
| SEN5166 | 5/16" x 6" | 0.68 LB | 10 PC | 30 PACK | 1 PACK |



| ITEM CODE | ITEM SIZE | PACK WEIGHT | PACK COUNT | BOX COUNT | PURCHASE UNIT |
|-----------|-----------|-------------|------------|-----------|---------------|
| SEN386 | 3/8" x 6" | 1.57 LB | 10 PC | 30 PACK | 1 PACK |

BITS & BIT TIP HOLDERS



| ITEM CODE | ITEM SIZE | PACK WEIGHT | PACK COUNT | BOX COUNT | PURCHASE UNIT |
|-----------|----------------------|-------------|------------|-----------|---------------|
| BITP2-25 | 1" #2 Bit (Phillips) | 0.31 LB | 25 PC | 12 PACK | 1 PACK |



| ITEM CODE | ITEM SIZE | PACK WEIGHT | PACK COUNT | BOX COUNT | PURCHASE UNIT |
|-----------|------------------------------|-------------|------------|-----------|---------------|
| BITP2R-25 | 1" #2 Bit (Reduced Phillips) | 0.3 LB | 25 PC | 12 PACK | 1 PACK |



| ITEM CODE | ITEM SIZE | PACK WEIGHT | PACK COUNT | BOX COUNT | PURCHASE UNIT |
|-----------|----------------------|-------------|------------|-----------|---------------|
| BITP3-25 | 1" #3 Bit (Phillips) | 0.3 LB | 25 PC | 12 PACK | 1 PACK |



| ITEM CODE | ITEM SIZE | PACK WEIGHT | PACK COUNT | BOX COUNT | PURCHASE UNIT |
|-----------|----------------------------|-------------|------------|-----------|---------------|
| HOB3 | 3" Magnetic Bit Tip Holder | 0.88 LB | 25 PC | 12 PACK | 1 PACK |



| ITEM CODE | ITEM SIZE | PACK WEIGHT | PACK COUNT | BOX COUNT | PURCHASE UNIT |
|-----------|----------------------------|-------------|------------|-----------|---------------|
| HOB6 | 6" Magnetic Bit Tip Holder | 1.18 LB | 25 PC | 12 PACK | 1 PACK |

TARPS



Heavy Duty Silver Tarp

SIZES AVAILABLE:
6' X 8' - 40' X 40'



Blue Tarp

SIZES AVAILABLE:
5' X 7' - 20' X 40'

LEATHER POUCHES & HOLDERS

PDRW10T

- Heavy Duty Top Grain Leather
- Extra Wide Body and Pockets
- Reinforced Top Grain Corners
- 37 Washer Rivets for Extra Strength

10-Pocket Top Grain Drywall Pouch

ITEM WEIGHT 1.48 LB
BOX COUNT 20 POUCH
PURCHASE UNIT 1 POUCH



PDRW10S

- Heavy Duty Leather
- Double Reinforced Stitching and Rivets
- 2 Steel Loop Hammer Holders
- 10 Pockets

10-Pocket Suede Drywall Pouch

ITEM WEIGHT 1.3 LB
BOX COUNT 20 POUCH
PURCHASE UNIT 1 POUCH



PAPRN13



13-Pocket Suede Leather Tool Apron

ITEM WEIGHT 2.2 LB
BOX COUNT 20 POUCH
PURCHASE UNIT 1 POUCH



PNAIL2S

3-Pocket Top Split Grain Drywall Pouch

ITEM WEIGHT 0.65 LB
BOX COUNT 20 POUCH
PURCHASE UNIT 1 POUCH



PDRW8L





























PDRW8R

8-Pocket Top Grain Left/Right Handed Drywall Pouch

ITEM WEIGHT 1.11 LB
BOX COUNT 20 POUCH
PURCHASE UNIT 1 POUCH

LEATHER POUCHES & HOLDERS

| | | ITEM WEIGHT | BOX COUNT | PURCHASE UNIT | |
|--|---------------|---|-----------|---------------|---------|
|  | PELCTG | Heavy Duty Top Grain Leather Electrician Pouch | 1.2 LB | 20 | 1 POUCH |
|  | PELCOT | Heavy Duty Oil Tanned Leather Electrician Pouch | 1.4 LB | 20 | 1 POUCH |
|  | HHSTG | Top Grain Swivel Hammer Holder | 0.2 LB | 50 | 1 PC |
|  | HHFTG | Top Grain Fixed Hammer Holder | 0.2 LB | 50 | 1 PC |
|  | HHSTG | Top Grain Swivel Hammer Holder | 0.2 LB | 50 | 1 PC |
|  | HHSTG | Top Grain Swivel Hammer Holder | 0.2 LB | 50 | 1 PC |
|  | HHSTG | Top Grain Swivel Hammer Holder | 0.2 LB | 50 | 1 PC |
|  | HHSTG | Top Grain Swivel Hammer Holder | 0.2 LB | 50 | 1 PC |
|  | HHSTG | Top Grain Swivel Hammer Holder | 0.2 LB | 50 | 1 PC |
|  | HHSTG | Top Grain Swivel Hammer Holder | 0.2 LB | 50 | 1 PC |
|  | HHSTG | Top Grain Swivel Hammer Holder | 0.2 LB | 50 | 1 PC |
|  | HHSTG | Top Grain Swivel Hammer Holder | 0.2 LB | 50 | 1 PC |
|  | HHSTG | Top Grain Swivel Hammer Holder | 0.2 LB | 50 | 1 PC |
|  | HHSTG | Top Grain Swivel Hammer Holder | 0.2 LB | 50 | 1 PC |
|  | HHSTG | Top Grain Swivel Hammer Holder | 0.2 LB | 50 | 1 PC |
|  | HHSTG | Top Grain Swivel Hammer Holder | 0.2 LB | 50 | 1 PC |
|  | HHSTG | Top Grain Swivel Hammer Holder | 0.2 LB | 50 | 1 PC |
|  | HHSTG | Top Grain Swivel Hammer Holder | 0.2 LB | 50 | 1 PC |
|  | HHSTG | Top Grain Swivel Hammer Holder | 0.2 LB | 50 | 1 PC |
|  | HHSTG | Top Grain Swivel Hammer Holder | 0.2 LB | 50 | 1 PC |
|  | HHSTG | Top Grain Swivel Hammer Holder | 0.2 LB | 50 | 1 PC |
|  | HHSTG | Top Grain Swivel Hammer Holder | 0.2 LB | 50 | 1 PC |
|  | HHSTG | Top Grain Swivel Hammer Holder | 0.2 LB | 50 | 1 PC |
|  | HHSTG | Top Grain Swivel Hammer Holder | 0.2 LB | 50 | 1 PC |
|  | HHSTG | Top Grain Swivel Hammer Holder | 0.2 LB | 50 | 1 PC |
|  | HHSTG | Top Grain Swivel Hammer Holder | 0.2 LB | 50 | 1 PC |
|  | HHSTG | Top Grain Swivel Hammer Holder | 0.2 LB | 50 | 1 PC |

LEATHER BELTS

BELT2L



2" Top Grain Leather Work Belt with Foam Padding

ITEM WEIGHT 0.64 LB
BOX COUNT 50
PURCHASE UNIT 1 BELT

BELT234L



2-3/4" Top Grain Leather Work Belt with Foam Padding

ITEM WEIGHT 0.81 LB
BOX COUNT 50
PURCHASE UNIT 1 BELT

BELT2OIL



2" Oil Tanned Leather Belt

ITEM WEIGHT 0.57 LB
BOX COUNT 50
PURCHASE UNIT 1 BELT

BELT234OIL



2-3/4" Oil Tanned Leather Belt

ITEM WEIGHT 0.72 LB
BOX COUNT 50
PURCHASE UNIT 1 BELT

HARD HATS

HAH01W



White Hard Hat with Ratchet (ANSI Z89.1)

ITEM WEIGHT 1 LB
BOX COUNT 40
PURCHASE UNIT 1 PC

HAH01Y



Yellow Hard Hat with Ratchet (ANSI Z89.1)

ITEM WEIGHT 1 LB
BOX COUNT 40
PURCHASE UNIT 1 PC

SAFETY VESTS

Safety Vest Class 2



VES2S-GR2XL

VES2S-GRXL

VES2S-GRL

VES2S-GRM



VES2S-OR2XL

VES2S-ORXL

VES2S-ORL

VES2S-ORM

| COLOR | SIZE | BOX COUNT | PURCHASE UNIT |
|------------|----------|-----------|---------------|
| Lime Green | XX Large | 50 | 1 VEST |
| Lime Green | X Large | 50 | 1 VEST |
| Lime Green | Large | 50 | 1 VEST |
| Lime Green | Medium | 50 | 1 VEST |
| Orange | XX Large | 50 | 1 VEST |
| Orange | X Large | 50 | 1 VEST |
| Orange | Large | 50 | 1 VEST |
| Orange | Medium | 50 | 1 VEST |

Safety Vest Class 2 Deluxe



VES2D-GR2XL

VES2D-GRXL

VES2D-GRL

VES2D-GRM



VES2D-OR2XL

VES2D-ORXL

VES2D-ORL

VES2D-ORM

| COLOR | SIZE | BOX COUNT | PURCHASE UNIT |
|------------|----------|-----------|---------------|
| Lime Green | XX Large | 50 | 1 VEST |
| Lime Green | X Large | 50 | 1 VEST |
| Lime Green | Large | 50 | 1 VEST |
| Lime Green | Medium | 50 | 1 VEST |
| Orange | XX Large | 50 | 1 VEST |
| Orange | X Large | 50 | 1 VEST |
| Orange | Large | 50 | 1 VEST |
| Orange | Medium | 50 | 1 VEST |

Safety Vest Class 3



VES3-GRXL

VES3-GRL

VES3-GRM



VES3-ORXL

VES3-ORL

VES3-ORM

| COLOR | SIZE | BOX COUNT | PURCHASE UNIT |
|------------|---------|-----------|---------------|
| Lime Green | X Large | 50 | 1 VEST |
| Lime Green | Large | 50 | 1 VEST |
| Lime Green | Medium | 50 | 1 VEST |
| Orange | X Large | 50 | 1 VEST |
| Orange | Large | 50 | 1 VEST |
| Orange | Medium | 50 | 1 VEST |

 **Sur-Pro[®]**
DRYWALL STILTS



QUADLOCK

BY  **Sur-Pro**[®]

SINGLE SIDED STILTS

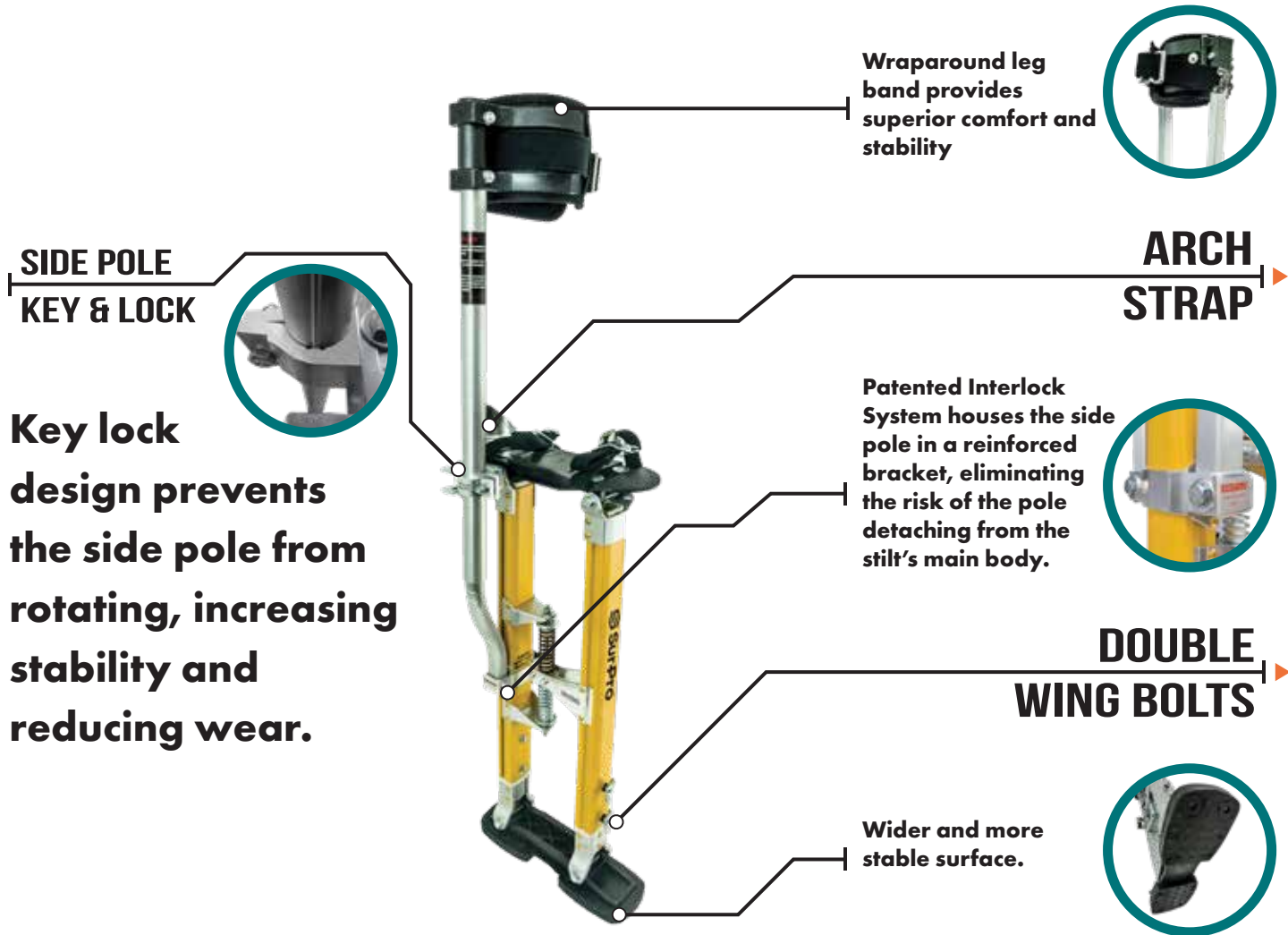

| | MATERIAL | MIN EXTENSION | MAX EXTENSION | ITEM WEIGHT | BOX DIMENSIONS | PURCHASE UNIT |
|-----------|-----------|---------------|---------------|-------------|----------------|---------------|
| SP-1830AP | ALUMINUM | 18" | 30" | 17 LB | 12"x10"x33" | 1 PAIR |
| SP-2440AP | ALUMINUM | 24" | 40" | 18 LB | 12"x10"x33" | 1 PAIR |
| SP-1830MP | MAGNESIUM | 18" | 30" | 16 LB | 12"x10"x33" | 1 PAIR |
| SP-2440MP | MAGNESIUM | 24" | 40" | 17 LB | 12"x10"x33" | 1 PAIR |

1523

1830

2440

ALUMINUM

MAGNESIUM

DOUBLE SIDED STILTS

DRYWALL STILTS

WRAPAROUND LEG BAND



Arch straps wrap around the ankle, increasing stability and offering a more natural placement of the foot.

INTERLOCK SYSTEM



Additional wing bolts improve the stability, safety and durability of the stilts.

EXTRA WIDE FOOT & FLOOR PLATE



DOUBLE LEG POLES

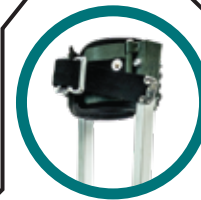

Patented dual leg pole design improves stability and comfort.

| | MATERIAL | MIN EXTENSION | MAX EXTENSION | ITEM WEIGHT | BOX DIMENSIONS | PURCHASE UNIT |
|------------|-----------|---------------|---------------|-------------|----------------|---------------|
| SP2-1830AP | ALUMINUM | 18" | 30" | 18 LB | 12"x10"x33" | 1 PAIR |
| SP2-2440AP | ALUMINUM | 24" | 40" | 19 LB | 12"x10"x33" | 1 PAIR |
| SP2-1830MP | MAGNESIUM | 18" | 30" | 17 LB | 12"x10"x33" | 1 PAIR |
| SP2-2440MP | MAGNESIUM | 24" | 40" | 18 LB | 12"x10"x33" | 1 PAIR |

SUR-STILTS

SS-1523AP

Single Sided Sur-Stilt
Aluminum 15"-23" Stilts

BOX WEIGHT 16 LB
BOX DIMENSIONS 12"x10"x33"
PALLET COUNT 32 PAIR



S2-1523AP

Double Sided Sur-Stilt
Aluminum 15"-23" Stilts

BOX WEIGHT 17 LB
BOX DIMENSIONS 12"x10"x33"
PALLET COUNT 32 PAIR



SS-1523MP

Single Sided Sur-Stilt
Magnesium 15"-23" Stilts

BOX WEIGHT 15 LB
BOX DIMENSIONS 12"x10"x33"
PALLET COUNT 32 PAIR



S2-1523MP

Double Sided Sur-Stilt
Magnesium 15"-23" Stilts

BOX WEIGHT 16 LB
BOX DIMENSIONS 12"x10"x33"
PALLET COUNT 32 PAIR



STILT REPLACEMENT KITS

SS1001

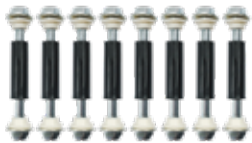

Hardware Kit for All
Sur-Pro Stilts

BOX WEIGHT 0.54 LB
BOX DIMENSIONS 8"x3.5"x1"

SS1002BK



Strap Kit for Single
Sided Sur-Pro Stilts

BOX WEIGHT 1.01 LB
BOX DIMENSIONS 8"x4.5"x2.8"

SS1003R



Floor Plate Kit for All
Sur-Pro Stilts

BOX WEIGHT 2 LB
BOX DIMENSIONS 11"x4"x4.5"

SS1004



Spring Kit for All
Sur-Pro Stilts

BOX WEIGHT 1 LB
BOX DIMENSIONS 9.5"x4.5"x1.5"

STILT REPLACEMENT KITS

SS1005P



Plastic Leg Band Kit for Single Sided Sur-Stilt Stilts

BOX WEIGHT 0.73 LB
BOX DIMENSIONS 7.5"x7.5"x4"

SS1005PF



Wraparound Leg Band Kit for Single Sided Sur-Pro Stilts

BOX WEIGHT 1.44 LB
BOX DIMENSIONS 10.5"x7.5"x4.5"

SS1006



Clamp and Bracket Kit for Single Sided Sur-Stilt Stilts

BOX WEIGHT 0.93 LB
BOX DIMENSIONS 8"x3.75"x2"

SS1007



Plastic Sleeve Kit for All Sur-Pro Stilts

BOX WEIGHT 0.11 LB
BOX DIMENSIONS 8.5"x4.5"x2"

SS1008



Wing Bolt Kit for All Sur-Pro Stilts

BOX WEIGHT 0.23 LB
BOX DIMENSIONS 4.5"x4"x1"

SS1009



Heel Bracket Kit for All Sur-Pro Stilts

BOX WEIGHT 0.26 LB
BOX DIMENSIONS 8.5"x4"x2.5"

SS1010R



Right Leg Band Kit for Double Sided Sur-Pro Stilts

BOX WEIGHT 0.82 LB
BOX DIMENSIONS 9"x8.5"x4"

SS1010L



Left Leg Band Kit for Double Sided Sur-Pro Stilts

BOX WEIGHT 0.82 LB
BOX DIMENSIONS 9"x8.5"x4"

SS1011



Strap Kit for Double Sided Sur-Pro Stilts

BOX WEIGHT 0.72 LB
BOX DIMENSIONS 8"x3.8"x2.3"

SS1012



Foot Plate Kit for All Sur-Pro Stilts

BOX WEIGHT 0.82 LB
BOX DIMENSIONS 11.5"x8"x2"

STILT REPLACEMENT PARTS



Leg Pole Lower Strut for Single Sided Stilts

| | WORKS WITH | ITEM WEIGHT | PURCHASE UNIT |
|------------------|--------------------------|-------------|---------------|
| H123-15AP | Sur-Stilt 15"-23" Stilts | 0.31 LB | 1 Pole |
| H123-18AP | QuadLock 18"-30" Stilts | 0.39 LB | 1 Pole |
| H123-24AP | QuadLock 24"-40" Stilts | 0.42 LB | 1 Pole |



Leg Pole Upper Strut for Single Sided Stilts

| | WORKS WITH | ITEM WEIGHT | PURCHASE UNIT |
|--------------|------------------|-------------|---------------|
| H105 | Sur-Stilt Stilts | 0.39 LB | 1 Pole |
| HP105 | QuadLock Stilts | 0.39 LB | 1 Pole |



Inner Extension Tube with Nylon Sleeves

| | WORKS WITH | ITEM WEIGHT | PURCHASE UNIT |
|-------------------|--------------------------|-------------|---------------|
| H151W-15AP | Sur-Stilt 15"-23" Stilts | 0.41 LB | 1 Tube |
| H151W-18AP | QuadLock 18"-30" Stilts | 0.48 LB | 1 Tube |
| H151W-24AP | QuadLock 24"-40" Stilts | 0.6 LB | 1 Tube |



Side Pole with End Cap and Side Pole Holder for Double Sided Stilts

| | WORKS WITH | ITEM WEIGHT | PURCHASE UNIT |
|-------------------|--------------------------|-------------|---------------|
| H165W-15AP | Sur-Stilt 15"-23" Stilts | 0.43 LB | 1 Pole |
| H165W-18AP | QuadLock 18"-30" Stilts | 0.49 LB | 1 Pole |
| H165W-24AP | QuadLock 24"-40" Stilts | 0.52 LB | 1 Pole |



Velcro Arch Strap

| | ITEM LENGTH | ITEM WIDTH | PURCHASE UNIT |
|--------------|-------------|------------|---------------|
| H107L | 20" | 1½" | 1 Strap |



Velcro Toe Strap

| | ITEM LENGTH | ITEM WIDTH | PURCHASE UNIT |
|--------------|-------------|------------|---------------|
| H108L | 15½" | 1" | 1 Strap |



MERCHANDISE DISPLAYS

Contact us at

1.800.443.8889 to obtain
more information on how to
get a merchandise display
in your store.



MERCHANDISE DISPLAYS

48

MERCHANDISE DISPLAYS

MERCHANDISE DISPLAYS



DRYWALL TOOLS

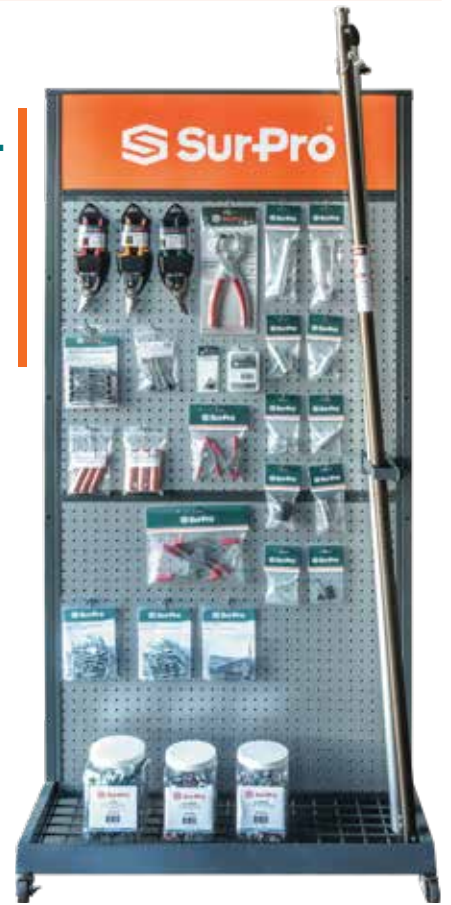

ACOUSTICAL TOOLS



WORK GEAR



STILTS & ACCESSORIES

49



Sur-Pro[®]

The Sur-Pro[®] brand is licensed exclusively to the following companies

Magnum Tool Corp., Inc.
5600 Bonhomme Rd.
Suite B
Houston, TX 77036

The Forest Group, Inc.
5600 Bonhomme Rd.
Suite C
Houston, TX 77036

www.sur-pro.com
www.stilts.com
Email: sur-pro@stilts.com
Phone: 1.888.443.8889

Be Sure.